

# TALENT

— By Alegre Design —

 commercialimages  
evolving workspaces





**TALENT SERIE 100 - Fixed desks with levellers**

Straight desks, 60 cm depth

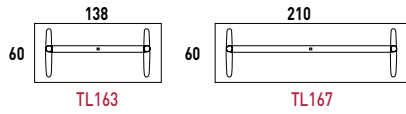

Straight desks, 69 cm depth

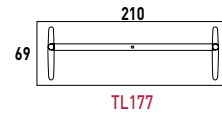

Straight progressive desks, 60 cm depth

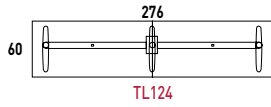

**TALENT SERIE 300 - Fixed desks with castors and folding desk-top**

Straight desks, 69 cm depth

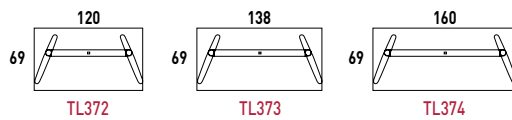

Straight desks, 80 cm depth

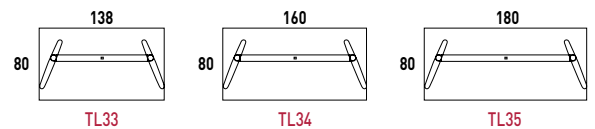

**TALENT SERIE 500 - Height adjustable desks with castors and folding desk-top**

Straight desks, 69 cm depth

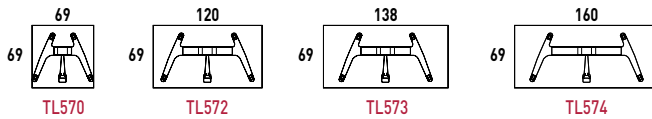

Straight desks, 69 cm depth with wiring access incorporated

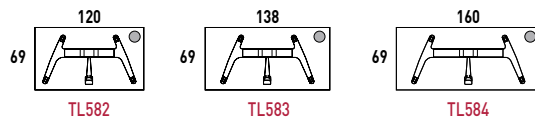

**AVAILABLE FINISHES:**

**Desk-top Finishes**



**Structure Finishes**

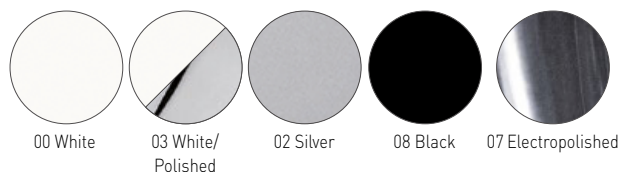

**TALENT SERIE 100 - Fixed desks with levellers**



- 1 25 mm melamine desk-top with straight PVC edge.
- 2 3 mm folded steel plate bracket in a white, black and aluminised finish with an epoxy paint coating.
- 3 70x40 and e=2 steel tube recessed crossbar with bumper edge to safely support the desk top.
- 4 Ø60 mm extruded aluminium column in a white, black and aluminised finish with an epoxy paint coating.
- 5 Straight aluminium injection legs in a white, black or aluminised finish, with an epoxy paint coating and polished aluminium finish.
- 6 Ø46mm levellers with non-skid patch.

**Optional Accessories:**

**Cable Access Management**



Ø80mm "U" cable access



Push Latch "T" cable access



Metal tray for "T" type cable access



Individual metal cable tray



Polypropylene flexible cable routing

**Modesty Panel**



Melamine or steel

**Desk Top Screens**



TALENT offers a variety of options in screens. Fully upholstered, with aluminium profiles or rails for attaching 3rd-level elements, melamine, glass or methacrylate

**CPU Holder**



Fixed to the cross beam

**Linking Desks**



Quick linking system. The desks are prepared to be linked laterally and frontally. They are fixed using an e=4mm plastic bracket

**TALENT SERIE 300 - Fixed desks with castors and folding desk-top**

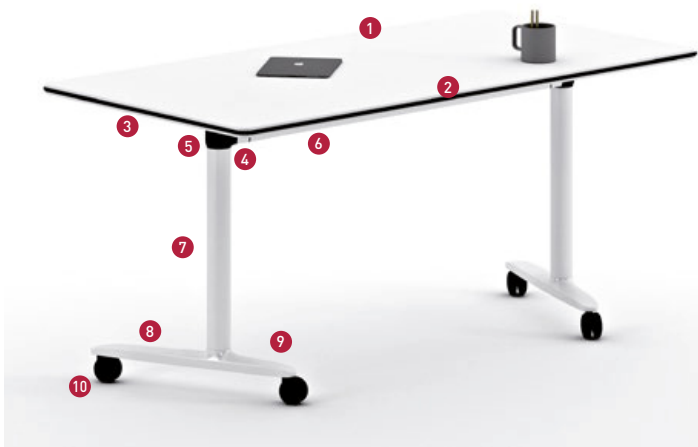

- 1 25 mm melamine desk-top with PVC edge and shock absorbing rubber.
- 2 Folding desk top with locking/unlocking system.
- 3 Aluminium injection bracket in a white, black and aluminised finish with an epoxy paint coating.
- 4 Injected aluminium corner joint for attaching columns and crossbars.
- 5 Polypropylene vertical stacking cap.
- 6 73x70 and e=2 mm extruded aluminium recessed crossbar with bumper to safely support the desk top.
- 7 Ø60 mm extruded aluminium column in a white, black, aluminised finish with an epoxy paint coating and electropolished with polished finish.
- 8 Straight aluminium injection legs in a white, black and aluminised finish with an epoxy paint coating and polished aluminium finish.
- 9 Stacking protection on the legs.
- 10 Black, 65 mm diameter wheels. 2 with brake and 2 without brake.

**Positioning legs in an angular position**

The standard 300 SERIES offer 2 different angle positions by positioning the feet in 2 positions, so they can be angled or straight depending on the vertical stackability required.

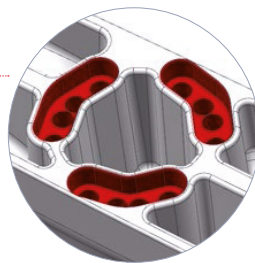
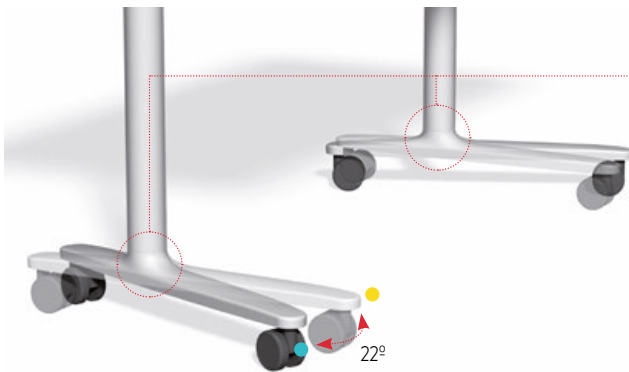

● Positioning the leg at a 22° angle

● Positioning the leg in a straight position

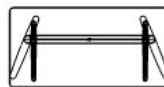

**Folding the desk top desk-top:**

The 300 SERIES offers a folding system for the work desk-top, using a system in the brackets that features a locking and unlocking position for the mechanism. At the same time, this folding allows the desks to be stacked, thus saving space. The desks come with a protector on the legs for stacking.

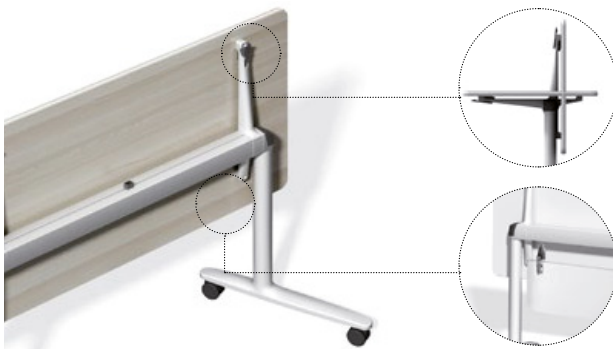

Locking/unlocking system for folding the work desk-top. **2 positions**

Folding modesty panel fixed to the desk top in a melamine finish.



**Optional Accessories:**

**Cable Access Management**



Ø80mm "U" cable access



Push Latch "T" cable access



Metal tray for "T" type cable access



Polypropylene flexible cable routing

**Folding Modesty Panel Linking of Desks**



Melamine modesty panel



Quick linking. The desks are prepared to be linked laterally and frontally. They are fixed using a e=4mm plastic bracket

Linking device system for desks – TALENT 100 and TALENT 300



TALENT, in its 100 and 300 series, offers a fast linking device system for desks, thus permitting different configurations, making the desks stable and ensuring there is no unwanted movement while they are being used.

The desks are prepared to be linked laterally and frontally, using a e=4mm plastic bracket, which features a quick and simple linking device system.



Desk Models with Linking Device Systems

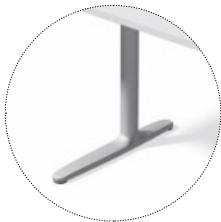

**TALENT SERIE 100 - Fixed desks with levellers**

**LATERAL LINKS**

Straight desks, 60 cm depth

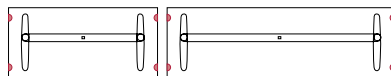

Straight desks, 69 cm depth

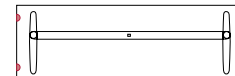

**TALENT SERIE 300 - Fixed desks with castors and folding desk-top**

**SIDE AND FRONT LINKS**

Straight desks, 69 cm depth

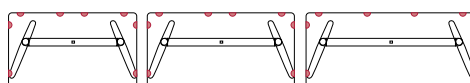

Straight desks, 80 cm depth

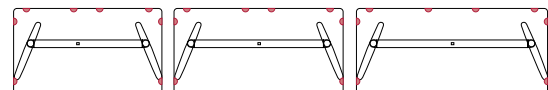

Configuration Examples

Side linking

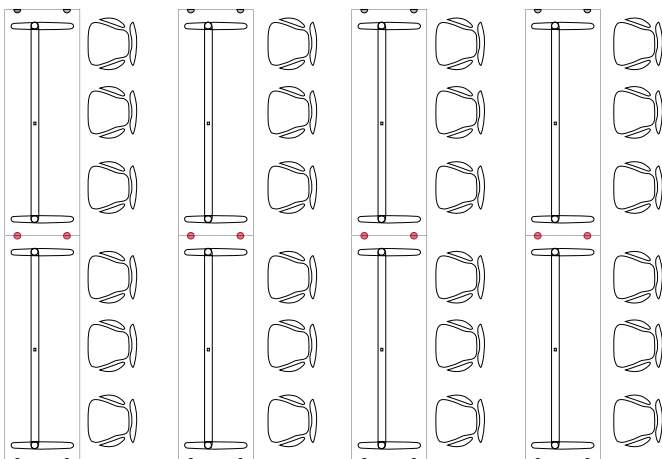

Front and side linking

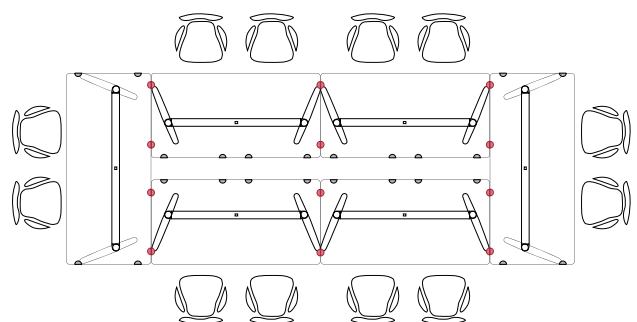

**TALENT SERIE 500 - Height adjustable desks with castors and folding desk-top**



- 1 25 mm melamine desk-top with PVC bumper edge.
- 2 Folding desk top with locking/unlocking system.
- 3 Aluminium injection bracket in a white, black and aluminised finish with an epoxy paint coating.
- 4 Injected aluminium corner joint for attaching columns and crossbars.
- 5 Polypropilene vertical stacking cap.
- 6 Elevation system in the desk via a gas lift.
- 7 73x70 and e=2 mm extruded aluminium recessed crossbar, with bumper to safely support the desk top.
- 8 Injected aluminium telescopic central column with two 110x80 and 100x70 sections and e=2 mm, featuring gas lift elevation system, in a white, black and aluminised finish with an epoxy paint coating.
- 9 Aluminium injection legs with lateral junction, in a white, black and aluminised finish with an epoxy paint coating and polished aluminium finish.
- 10 Stacking protection on the legs.
- 11 65 mm diameter black wheels. 2 with brakes and 2 without brakes.

**Desk Elevation System:**

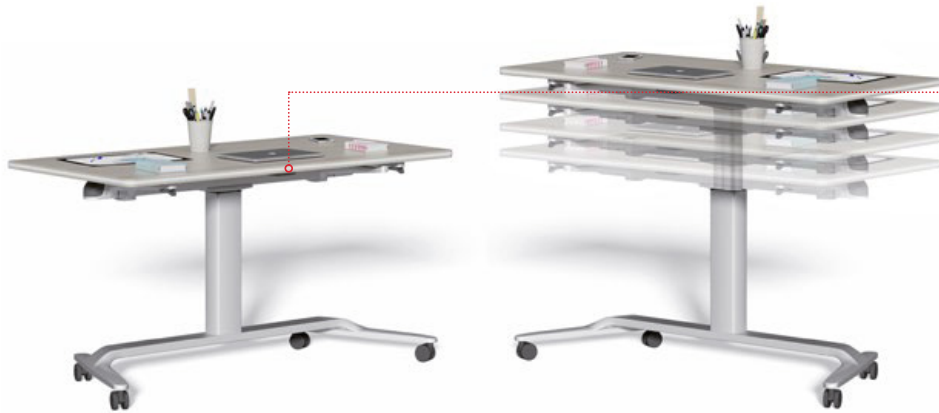

The 500 SERIES has a push button under the desk top that is easily accessible, which allows the desk to be elevated using a gas lift. Height range: 74-104 cm.

**Folding the desk top desk-top:**

The 500 SERIES offers a folding system for the work desk-top, using a system in the brackets with a locking and unlocking position for the mechanism. At the same time, this folding allows the desks to be stacked, thus saving space. The desks come with a protector on the legs for stacking.

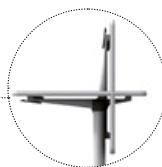

Locking/unlocking system for folding the work desk-top.  
**2 positions**



**TALENT SERIE 500 - Height adjustable desks with castors and folding desk-top**

Talent Desks with Laminated Writable Desk-top and dry wipeable

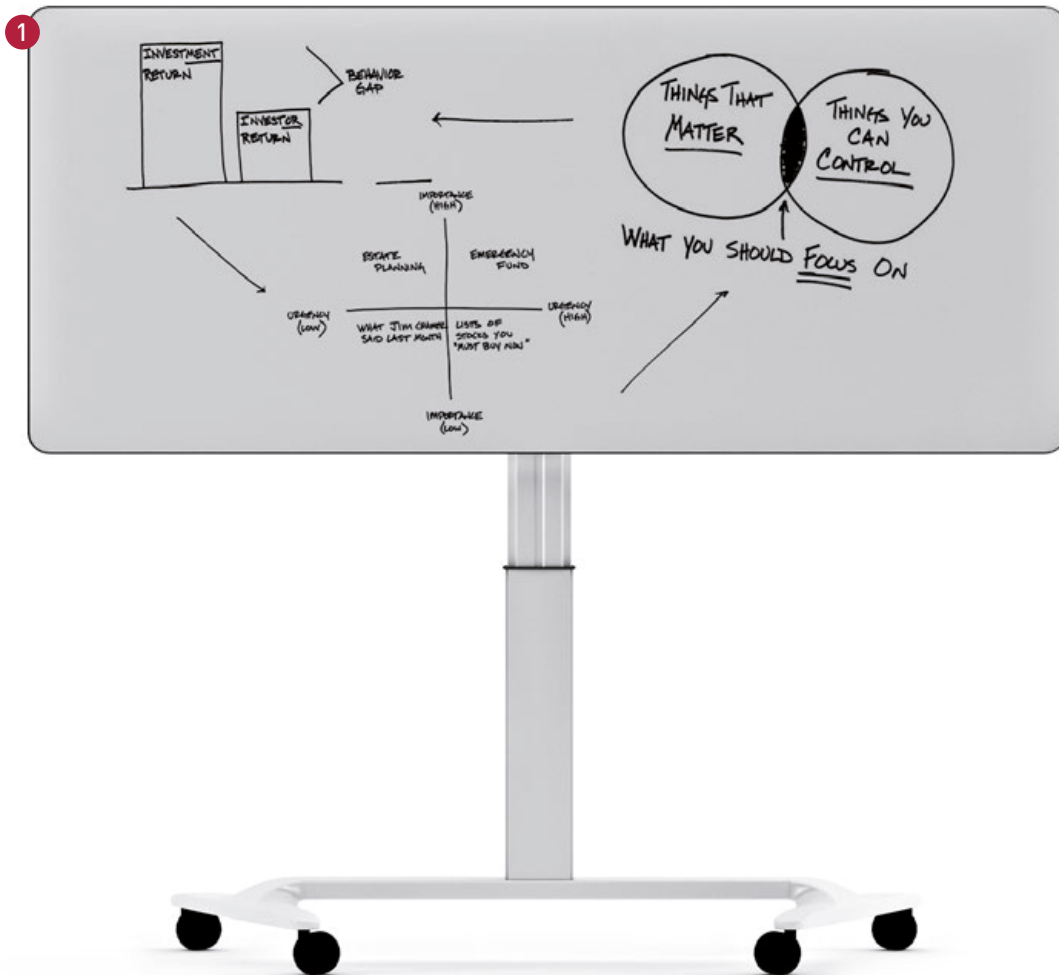

- 1 • 24 mm HPL desk-top with PVC edge and shock-absorbing rubber.
- White laminated melamine desk-top, suitable for writing directly on it with dry erase markers.
- Easily erased and cleaned with a simple cloth or rubber.



**Cleaning the Desk-top**

Easily erased and cleaned with a simple dry cloth or rubber, even when the writing has been there for a while. The use of chemical products for cleaning the desk-top is not recommended.



**Markers for Writing**

To correctly write on the desk-top, the use of **dry erase markers** is recommended in order to lengthen the desk desk-top's useful life.

**TALENT SERIE 500 - Height adjustable desks with castors, folding desk-top and wiring access incorporated**

**Talent Desks with connectivity without detracting from mobility**



- 1** All models incorporate integrated connection access to the table surface with a plug.

  - High-impact fire-resistant polycarbonate housing.
  - Silver ring as standard
  - Large plastic locking nut that can be tightened by hand Ø79mm
  - 1 x schucko, + 2 USB-charger
  - Dimensions: Ø10,8 x h:15,3cm
- 2** Hook made of 3 mm thick steel plate, anchored to the bracket with capacity to pick up the wiring easily and cleanly.
- 3** Metal riser cables, made of 0,8 mm thick sheet steel, which allows simple wiring guidance, providing visual cleanliness.
- 4** Built-in 3m long cable wrapped in textile cable riser, with zipper system, with additional protection against flames and abrasion.





**MATERIALS**

Maximum use of materials to eliminate and minimize scraps. Use of recyclable and recycled materials in those components that do not affect the functionality and durability.

Serie 100: **67,24%**  
Serie 300: **69,87%**  
Serie 500: **62,99%**

RECYCLED MATERIALS



**PRODUCTION**

Maximum optimization of energy use. Minimal environmental impact. Last generation technological systems. Zero discharge of wastewater. No VOC coatings. Processes free of heavy metals, phosphates, OC and COD.

**100%**  
RECYCLABLE  
ALUMINIUM, STEEL & WOOD



**TRANSPORT**

Detachable systems. Volumes that facilitate the optimization of space. Maximum reduction of energy consumption by transport.

**100%**  
RECYCLABLE  
PACKAGE AND THINNER FREE



**USE**

Quality and warranty. Long lasting. Replacements available.

**EASY**  
TO CLEAN AND MAINTAIN



**DISPOSAL**

Waste reduction. Supplier-manufacturer packaging reuse system. Components are easy to be separated. Inks in packaging are water-based, without solvents.

Serie 100: **91,83%**  
Serie 300: **97,89%**  
Serie 500: **91,32%**

RECYCLABLE MATERIALS

■ **CERTIFICATES AND REFERENCES**

The different programmes get points in different environmental categories to get the LEED certificate or WELL certificate (sustainability, material and resources, water, energy and atmosphere, inner environment quality, innovation and design).



■ **STANDARDS**

Talent 300 has passed tests done in our technical department as well as the tests done in AIDIMA the Technological Institute for furniture. The tests correspond to:

- **UNE: EN 527-1:2011.** Office Furniture. Desks. Part 1: Dimensions.

Talent 500 has passed tests done in our technical department as well as the tests done in AIDIMA the Technological Institute for furniture. The tests correspond to:

- **UNE-EN 15372:2017.** Furniture. Strength, durability and safety. Requirements for non-domestic tables.
- **GS-CERTIFIED.** Product in compliance with the product safety law with regard to the guarantee of safety and health.
- **UNE EN ISO 14006: 2019.** Environmental management system. Guidelines for incorporating ecodesign.